

ONLINE RESOURCES

Free Programming Software

Your S3 robot contains a reprogrammable brain, the Propeller P8X32A multi-core microcontroller. You can write your own S3 programs with several software and programming language options. Some use pictures, some use text, all are free downloads available from www.parallax.com/S3.

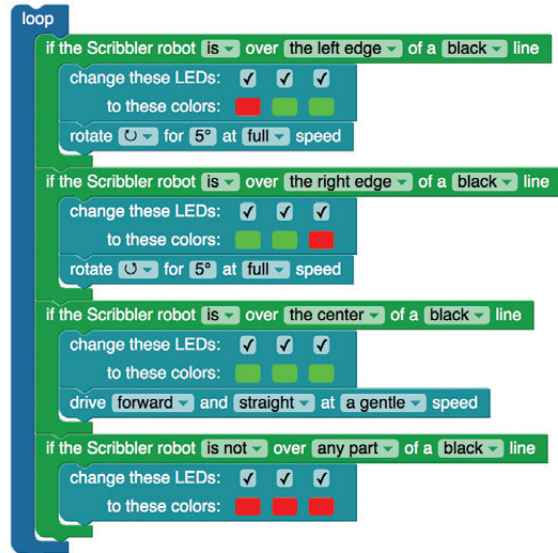

S3 Tutorials and Projects

Explore tutorials and projects for the S3. You will find guides for getting started with different S3 software options, fun projects, resources for teachers, and tips especially for hackers.

<http://learn.parallax.com/S3>

S3 ROBOT PRODUCT INFO

S3 Robot (Part #28333) - Please read and retain this instruction booklet. The S3 robot is not a toy. This product has moving parts and accessible electronic components. Only skilled experimenters should customize or hack an S3 robot, after reading and understanding all the detailed information available from www.parallax.com/S3.

Contents

S3 Robot (fully assembled), S3 LiPo Battery (#752-28333), S2/S3 Motor Assembly (#750-28330), S3 Programming/Charging Cable (#805-00017)

Battery Info

The S3 robot includes a rechargeable battery, Parallax part number #752-28333. This is a 3.7 V, 4000 mAh, 14.8 Wh, Prismatic LiPo battery with a JST RCY connector and built in PCM providing overcurrent, overdischarge, and short-circuit protection.

FCC Notice

This equipment has been tested and found to comply with the limits for a class B digital device, pursuant to Part 15 of the FCC Rules. These limits are designed to provide reasonable protection against harmful interference in a residential installation. This equipment generates, uses, and can radiate radio frequency energy and, if not installed and used in accordance with the instructions, may cause harmful interference to radio communications. However, there is no guarantee that interference will not occur in a particular installation. If this equipment does cause harmful interference to radio or television reception, which can be determined by turning the equipment off and on, the user is encouraged to try to correct the interference by one or more of the following measures:

- Reorient or relocate the receiving antenna.
- Increase the separation between the equipment and receiver.
- Connect the equipment into an outlet on a circuit different from that to which the receiver is connected.
- Consult the dealer or an experienced radio/TV technician for help.

S3 ROBOT SAFETY

Battery Safety

- Only use the Parallax S3 Battery included with your S3 robot.
- Only use the Parallax S3 Programming/Charging Cable included with your S3 robot.
- Before connecting your robot to a computer or charger each time, open the battery hatch and check the condition of the battery. If it is bulging, leaking, or discolored, stop and do not use the battery. Immediately place battery outside in a fireproof container. Contact Parallax Tech Support.
- Recharge the battery only as described in the Battery Charging section. Do not use other types of hobby battery rechargers.
- If battery fault occurs as described in the Battery Charging section, contact Parallax Tech Support.
- Only adults should install and replace batteries.
- Do not short circuit the battery supply terminals.
- Dispose of batteries safely, following your local ordinances for LiPo battery recycling or disposal. Do not dispose of the battery in a fire; it may explode.

Caution: Hair entanglement hazard. Keep hair from coming in contact with moving wheels of robot.



This symbol on the S3 or its packaging indicates that this product must not be disposed of with your other household waste. Instead, it is your responsibility to dispose of your waste equipment by handing it over to a designated collection point for the recycling of waste electrical and electronic equipment. The separate collection and recycling of your waste equipment at the time of disposal will help conserve natural resources and ensure that it is recycled in a manner that protects human health and the environment. For more information about where you can drop off your waste for recycling, please contact your local authority, or where you purchased your product.

BATTERY USE

Installation

1. Place the S3 on a towel (or other non-scratching surface), bottom side up.
2. Remove the battery cover by pulling the battery cover latches down toward the tail wheel, and then lift the battery cover up.
3. Look at the battery. If it is bulging, leaking, or discolored, stop and do not use the battery. Contact Parallax Tech Support. Otherwise, go to the next step.
4. Connect the cable on the S3 battery to the connector inside the battery compartment. Verify that the black wires connect to each other and the red wires connect to each other, then slide ends together until they click into place.
5. Replace the battery cover.
6. Turn the robot over and look for the lower-right power indicator LED. If the battery voltage is okay, it will be solid blue. If the battery voltage is low, the LED will slowly blink. If it is off, the battery may be completely discharged (or not completely plugged in).
7. Recharge the battery if needed.

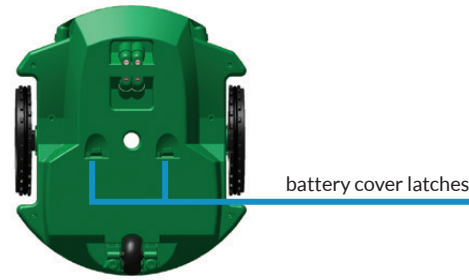

Charging

1. Connect the included USB cable to one of the following:
 - A standard USB wall adapter, up to 2 A maximum charging current
 - A USB port on a computer
2. Connect the S3 robot to the USB cable.
3. Turn off the robot by holding down the Power Button for two seconds. The Power LED (above the Power Button on the right) will turn off.
4. Charging the robot may take 2 to 3 hours with a 10 W USB wall adapter, or 8-10 hours via a computer port or 2.5 W USB wall adapter.
5. Observe the Charging LED (to the right of the USB port).
 - Solid blue = full
 - Solid red = charged
 - Blinking red/blue = charging fault. Check the following:
 - Battery may be disconnected or not plugged in completely. Unplug USB cable and the battery connector, wait a few minutes, and then repeat the Installation Instructions above.
 - Battery may be defective. Unplug the USB cable and battery, and contact Parallax Tech Support.

TOP VIEW

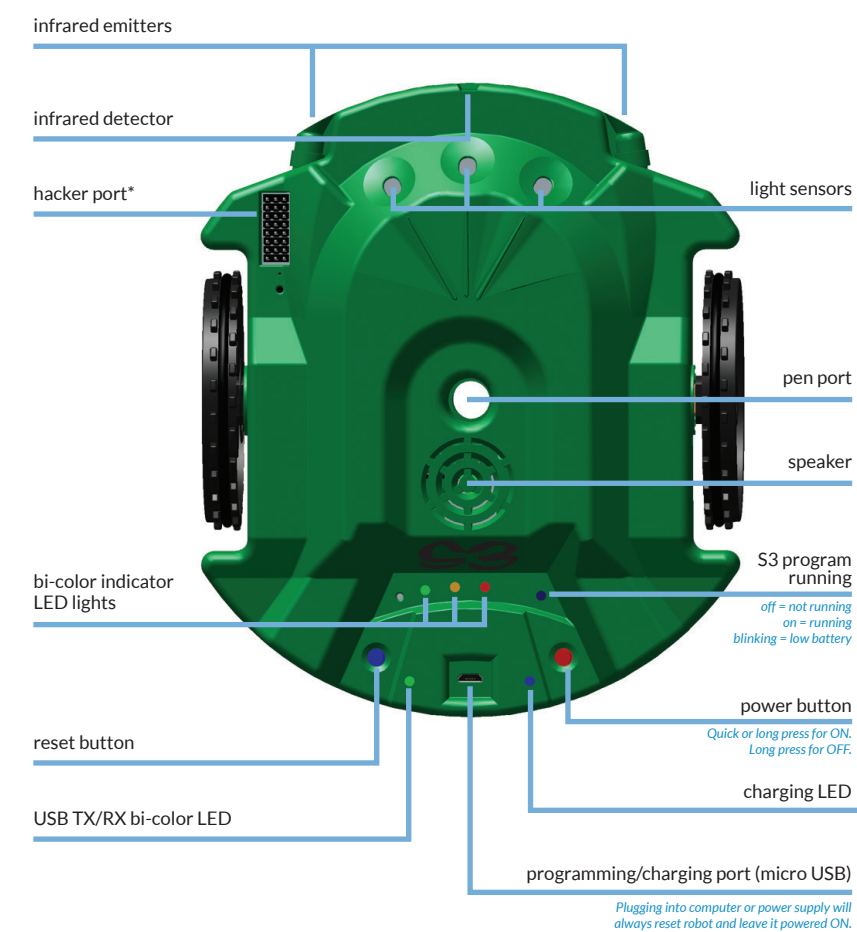

BOTTOM VIEW

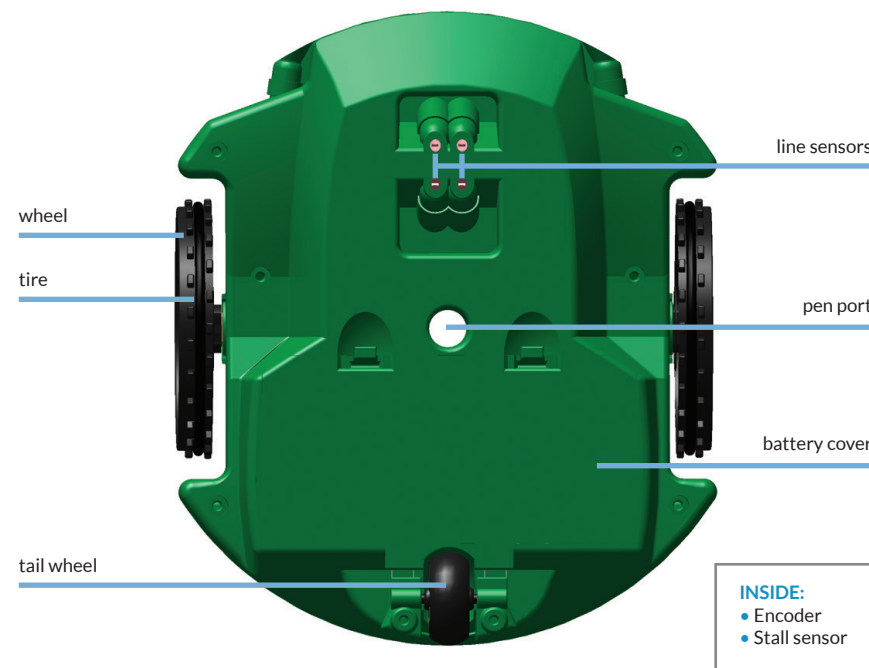

CONNECTED TO USB POWER†		NOT CONNECTED TO USB POWER	
LED Color	Battery Status	LED Color	Power Status
Red	Charging	Blue	On
Blue	Full	Off	Off
Flashing Red/Blue	Fault		

† Power status not indicated when connected to USB power

WARNING: Do not insert any object into sensor holes or any other part of the S3 robot case except as described in this S3 Start-Up Guide. This may damage the unit and will void the warranty.



HAVE A QUESTION? NEED TECHNICAL SUPPORT?

Please contact Parallax directly for help!

- Web site: www.parallax.com/S3
- Email: support@parallax.com
- Toll free technical support (in the U.S.): 888-99-STAMP
- Toll free sales and information (in the U.S.): 888-512-1024
- Office phone number: (916) 624-8333

S3 Robot (part #28333) - Please read and retain this instruction guide.

WARRANTY

Parallax Inc. warrants its products against defects in materials and workmanship for a period of 90 days from receipt of product. If you discover a defect, Parallax Inc. will, at its option, repair or replace the merchandise.

Scribbler is a registered trademark of Parallax Inc. The Parallax logo, S3, and the S3 logo are trademarks of Parallax Inc. Sharpie is a registered trademark of SANIFORD. Copyright © 2017 Parallax Inc. All Rights Reserved.

#125-28333 - Rev 032017

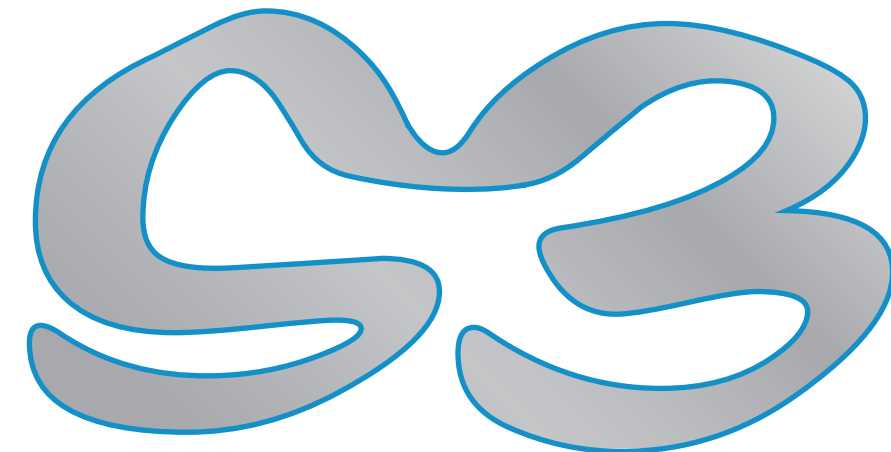

Scribbler® 3 Start-Up Guide

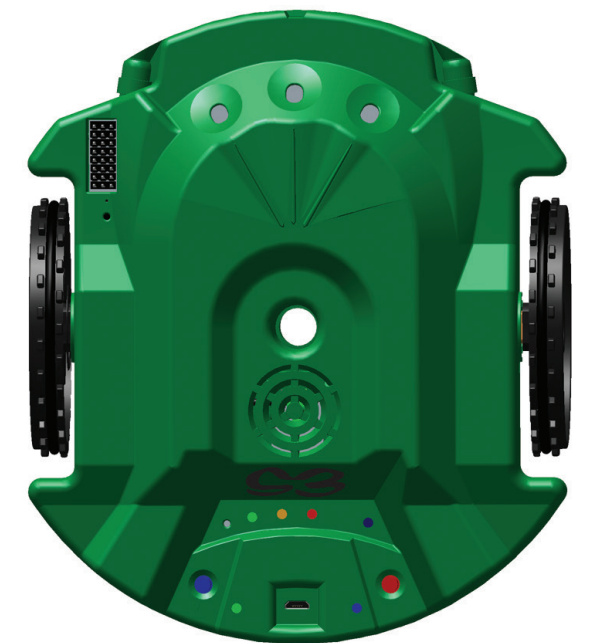

Propeller-powered and fully programmable
Open-source and user-hackable

*HACKER PORT

The Hacker Port lets you customize your S3 robot! These pins can connect optional sensors and other accessories to the S3's Propeller microcontroller brain. For information and ideas, visit <http://learn.parallax.com/S3>

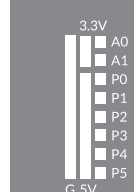

DEMO 1: LIGHT SENSORS

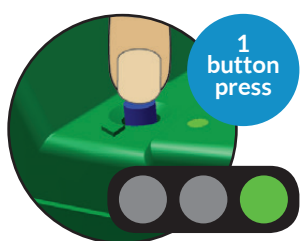

STEP 1: Place your S3 on the floor in a brightly lit room.

STEP 2: Press and release the power button. You will hear a song and all 3 LEDs will light up. The LEDs will be green in a bright room (and yellow in a dim room).

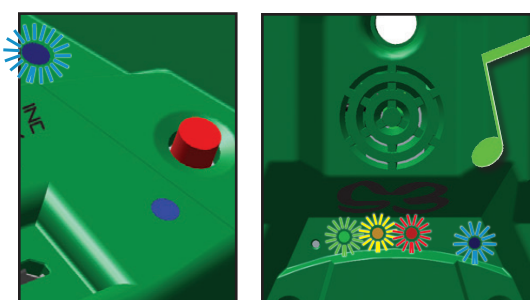

STEP 3: Cover a light sensor with your finger. An LED will turn off.

In this demo mode, the left light sensor controls the left LED, the center light sensor controls the center LED, and the right light sensor controls the right LED. Other demos will use the indicator LEDs in a different way.

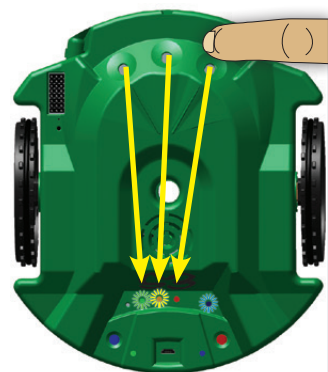

EXTRA: You can cover the sensors with your fingers then press and release the reset button to choose Demo modes. Binary 0 (all uncovered) = Demo 1, Binary 7 (all covered) = Demo 7.

DEMO 2: LIGHT-SEEKING BEHAVIOR

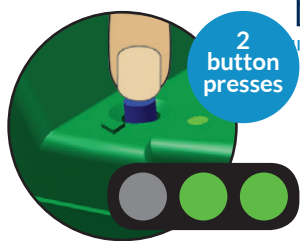

The three light sensors can detect bright light in front of the S3 robot. One sensor looks straight ahead, the other two look 30° to the right and the left.

STEP 1: Press the reset button 2 times.

STEP 2: The S3 will play a short song, then drive around the room seeking the brightest light within its view.



TRY THIS: In a dark room, hold a flashlight at floor level facing the S3 robot. As you move the flashlight around the floor, the S3 will follow it.

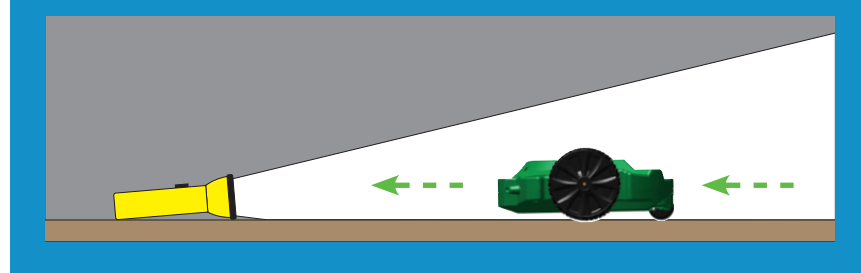

DEMO 3: OBJECT DETECTION

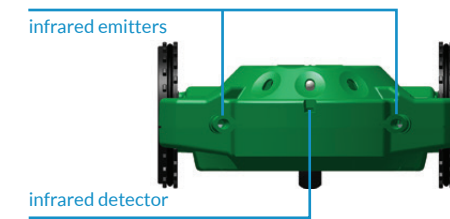
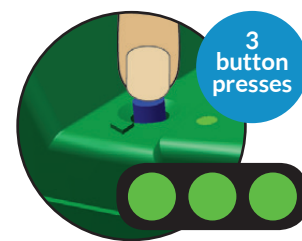

Infrared light shines from the emitters, even though your eyes cannot see it. The S3 robot can detect the light after it reflects off an obstacle and bounces back to its infrared detector "eye."

STEP 1: Press the reset button 3 times.

STEP 2: Place an object on the floor in front of the S3 robot. If the S3 sees the object on its right, the right LED turns on, and the speaker plays a tone. If no object is detected on the right side, the right LED turns red.

Similarly, if the S3 sees an object on its left, the left green LED turns on and the speaker plays a different tone. If no object is detected on the left side, the left LED turns red.

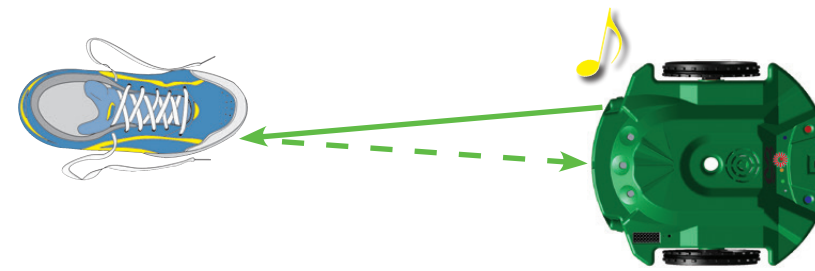

EXTRA: If the S3 can see the object with both sensors it will play both tones and both green LEDs will turn on. The S3 can usually see light objects better than very dark objects, because dark objects often do not reflect much infrared light.

DEMO 4: AVOIDING OBJECTS BEHAVIOR

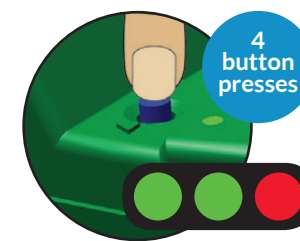

STEP 1: Press the reset button 4 times.

STEP 2: The S3 robot will drive around the room, turning to avoid objects.

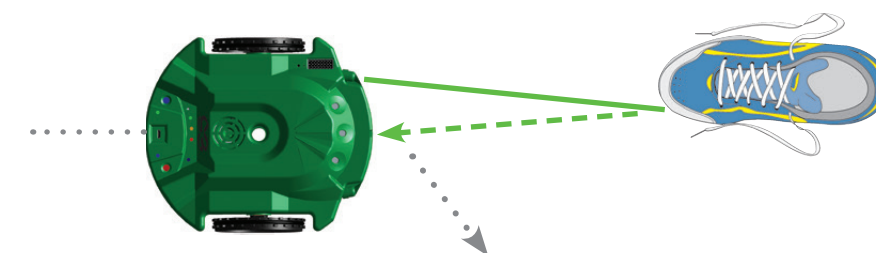

The S3's rear tail wheel is a stall sensor. If it get stalled on an object it cannot see, it will back up, turn, and try driving forward again.

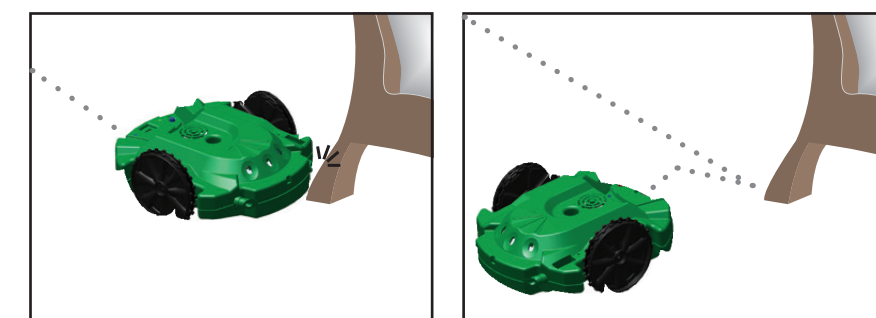

DEMO 5: LINE SENSORS

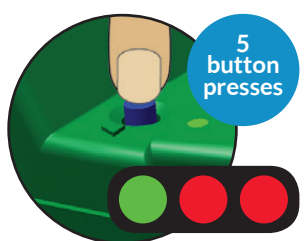

The S3 has two pairs of infrared emitters and detectors on its underside. With them, it can see a black line on white paper.

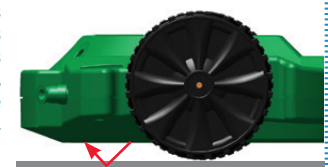

STEP 1: Print out a set of black lines from the "Tracks.pdf" (Download file from www.parallax.com/S3). Some inks work better than others. For best results we recommend a laser printer with low/no gloss paper.

Create your own tracks using a flat black electrical tape or by making a black line 3/4" (2 cm) wide, on white paper. Always protect surfaces with paper or poster board when using a marker or any other writing instrument in your S3. Be aware that some markers can bleed through paper and stain the surface beneath, so test first.

STEP 2: Press the reset button 5 times.

STEP 3: Place the S3 on the paper, and move it back and forth across the black line. If the right sensor sees the line, the right green LED will light up. If the left sensor sees the line, the left green LED will light up. If both sensors see the line, both green LEDs light up. The LEDs will be red if no line is detected.



EXTRA: The S3 robot must be resting on the paper to see the line.

DEMO 6: LINE FOLLOWING BEHAVIOR

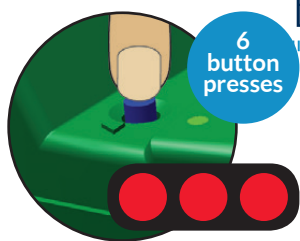

Make black lines on white paper as a track for the S3 robot to follow.



STEP 1: Print out a set of black lines from the "Tracks.pdf" (Download file from www.parallax.com/go/S3). Some inks work better than others. For best results we recommend a laser printer with low/no gloss paper.

Or draw your own tracks by making a black line 3/4 inch (2 cm) wide, on white paper. To do this you will need: white paper, and a black marker. Always protect surfaces with paper or poster board when using a marker or any other writing instrument in your S3. Be aware that some markers can bleed through paper and stain the surface beneath, so test first.

STEP 2: Place the track on a hard floor, and then place the S3 on the track.

STEP 3: Press the reset button 6 times.

STEP 4: Listen for the beep. After a short tune the S3 turns from side to side to find the line, then starts following it. If the S3 loses the line on a tight corner, it will turn back and forth to look for it again.

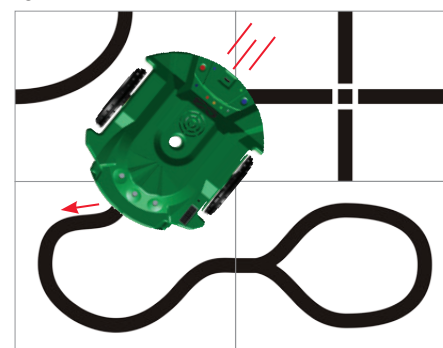

EXTRA: The S3 does best following black lines about 3/4 inch (2 cm) wide, on a white background. Line following works best when the track is placed on a hard, level surface. Carpet, tile, or other uneven surfaces may not work well. A dark surface may show through thin paper and make the line harder for the S3 to see.

DEMO 7: SCRIBBLE BEHAVIOR

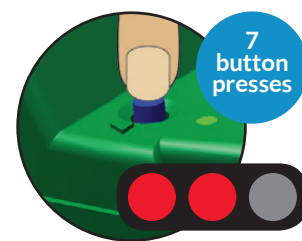

Find white paper or poster board and a marker.

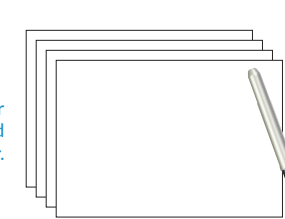

STEP 1: Place paper on the floor, and then place the S3 robot on the paper.

STEP 2: Place a Sharpie® marker in the pen port. The tip of the marker must touch the paper. Always protect surfaces with paper or poster board when using a marker or other writing instrument in your S3. Be aware that some markers can bleed through paper and stain the surface beneath. Test first.



STEP 3: Press the reset button 7 times.

STEP 5: Pick up the S3 and put it down on another part of the paper. Then it will draw a box.

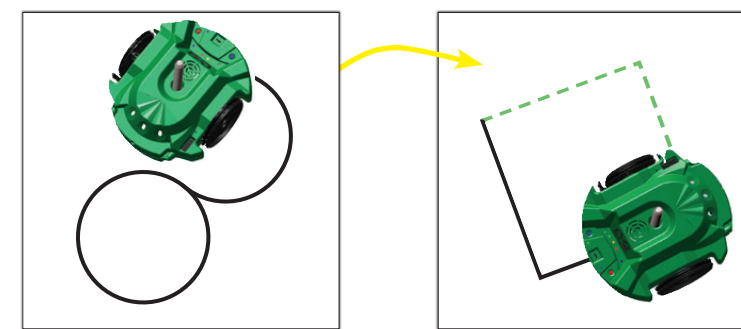

NOTE: Just like handwriting, each S3 drawing will be recognizable but unique every time you run a program. Variations occur as battery charge changes, motors warm up, and wheel joints relax with use over time.

DEMO 8: AMBULANCE BEHAVIOR

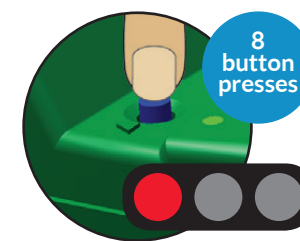

In this demo the S3 will use the infrared light emitter and detectors and stall sensors to detect obstacles.

STEP 1: Press the reset button 8 times.

STEP 2: The S3 robot drives around blaring its "siren" and flashing its lights, while avoiding walls and obstacles.

